

LPG-Series

Compressors and Stationary Pumps for LPG and NH₃ Bulk Plant Applications

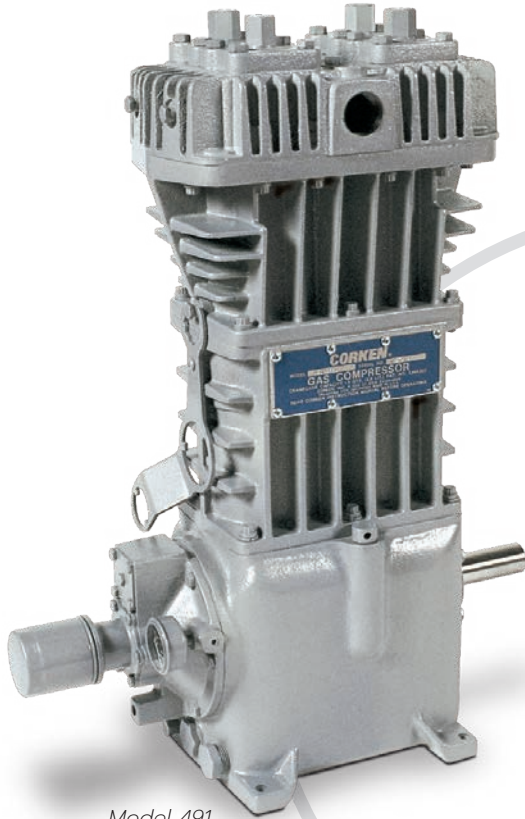

*Model 491
Compressor*

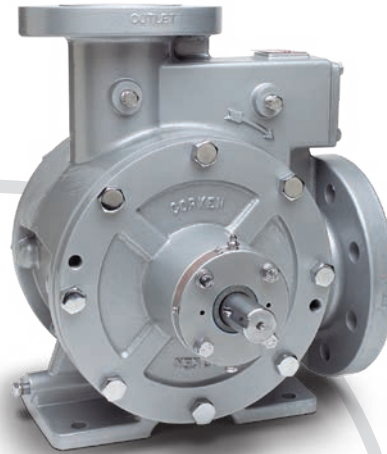

Model Z4500 Pump



Model C12 Pump

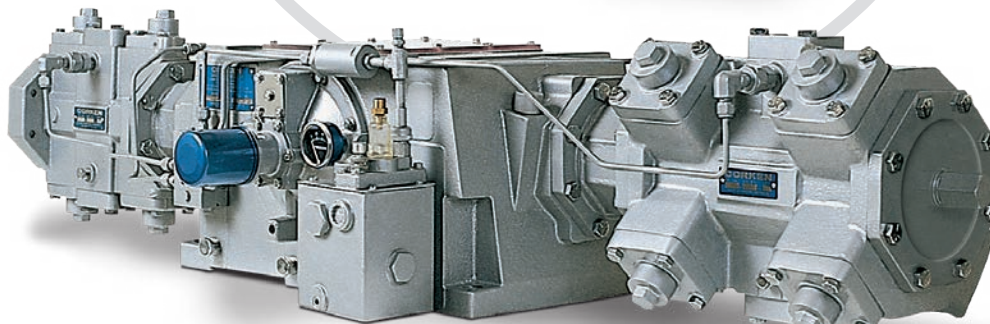

Model HG602 Compressor

CORKEN[®]

A Unit of IDEX Corporation

A Tradition of Excellence



Corken is a leading manufacturer of industrial compressors, pumps, bypass valves, and accessories designed for liquefied petroleum gas (LPG), anhydrous ammonia, and many other flammable, volatile, and toxic liquids and gases.

Located in Oklahoma City, Oklahoma, USA, Corken was founded in 1924 as a water and boiler feed pump distributor and quickly gained a reputation for excellence in customer service. In the mid-1940s, the company entered the LPG industry which proved to be a turning point. In the years to follow, Corken was recognized for its quality line of compressors, pumps, bypass valves, and accessories.

Many products meet multiple industry standards, including Underwriters Laboratories (UL), Canadian Standards Association (CSA), High Pressure Gas Safety

Institute of Japan (KHK), Bureau Veritas of France, European Union Pressure Equipment Directive (PED), ATEX Equipment Directive, European Union Machinery Directive, International Quality Standard (ISO 9001), and Environmental Management Standard (ISO 14001).

Today, Corken is a diversified company serving a worldwide customer base in Far East Asia, Africa, Europe, Middle East, South America, and North America. Each customer is served through an extensive network of distributors sharing the same commitment to customer service demonstrated by Corken for more than 90 years.

This exceptional reputation for customer service and quality products, combined with a strong commitment to technological innovation, has positioned Corken as a global leader in compression and pumping solutions.

CORKEN

LPG Product Overview

Sliding Vane Pumps

Applications:

- Barge unloading
- Delivery truck
- Butane bulk transfer
- Tank car unloading



Regenerative Turbine Pumps

Applications:

- Asphalt plants
- Cylinder filling
- Autogas dispensing
- Stand-by systems
- Bottle filling
- Vaporizer feed



Reciprocating Gas Compressors

Applications:

- Bulk transfer
- Liquid transfer/vapor recovery
- Cylinder filling
- Tank evacuation for maintenance
- Inert gas pad
- Truck/barge/tank car unloading



Bypass Valves

Applications:

- Bulk-plant installations for loading and unloading.
- Cylinder filling and aerosol propellant feed.
- Truck and transport loading and unloading.



Compressors, Pumps, and Acc

Tanker Unloading and Vapor Recovery:
Reciprocating compressor

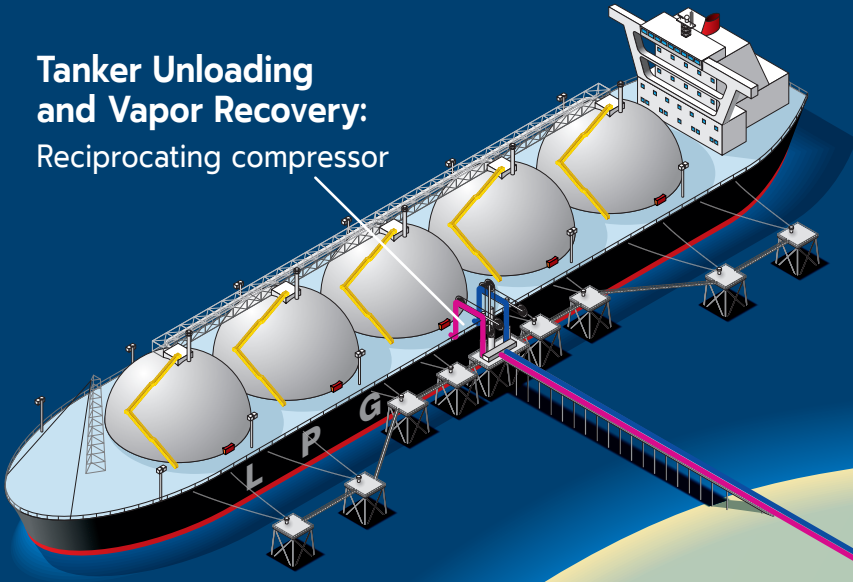

Transport Trailer Load & Unload:
Sliding vane pump
Reciprocating compressor

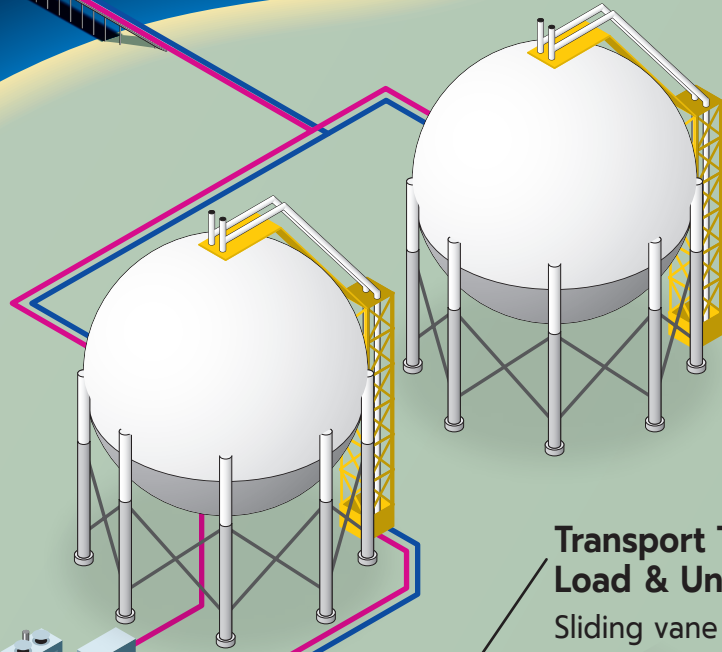

Vaporizer Feed for Plant Consumption:
Turbine pump
Sliding vane pump

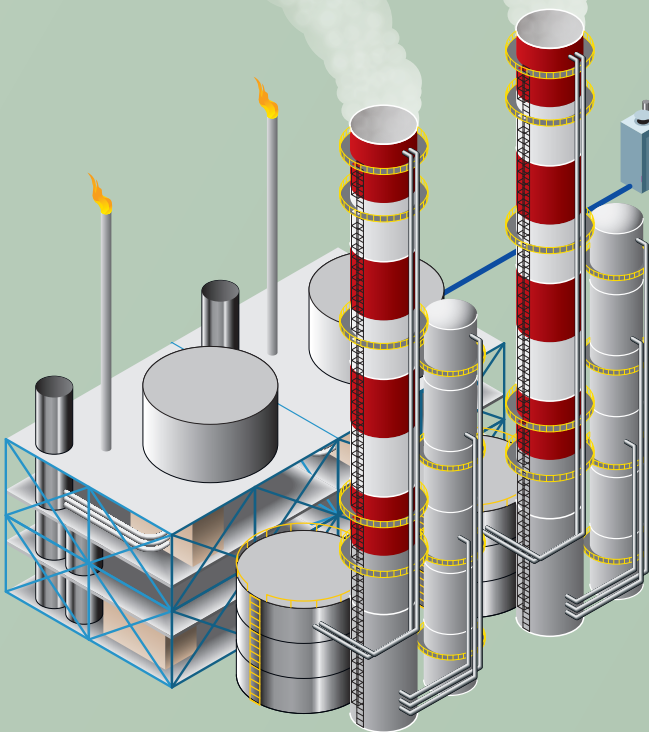

essories for All of Your Needs

Cylinder Evacuation:

Reciprocating compressor
Turbine pump
Sliding vane pump

Rail Car Unload and Vapor Recovery:

Reciprocating compressor

Cylinder Filling—Carousel:

Sliding vane pump

Cylinder Filling—Scales:

Turbine pump
Sliding vane pump

Bulk Load & Unload:

Sliding vane pump
Truck pump
Reciprocating compressor

Automotive Filling:

Turbine pump
Sliding vane pump

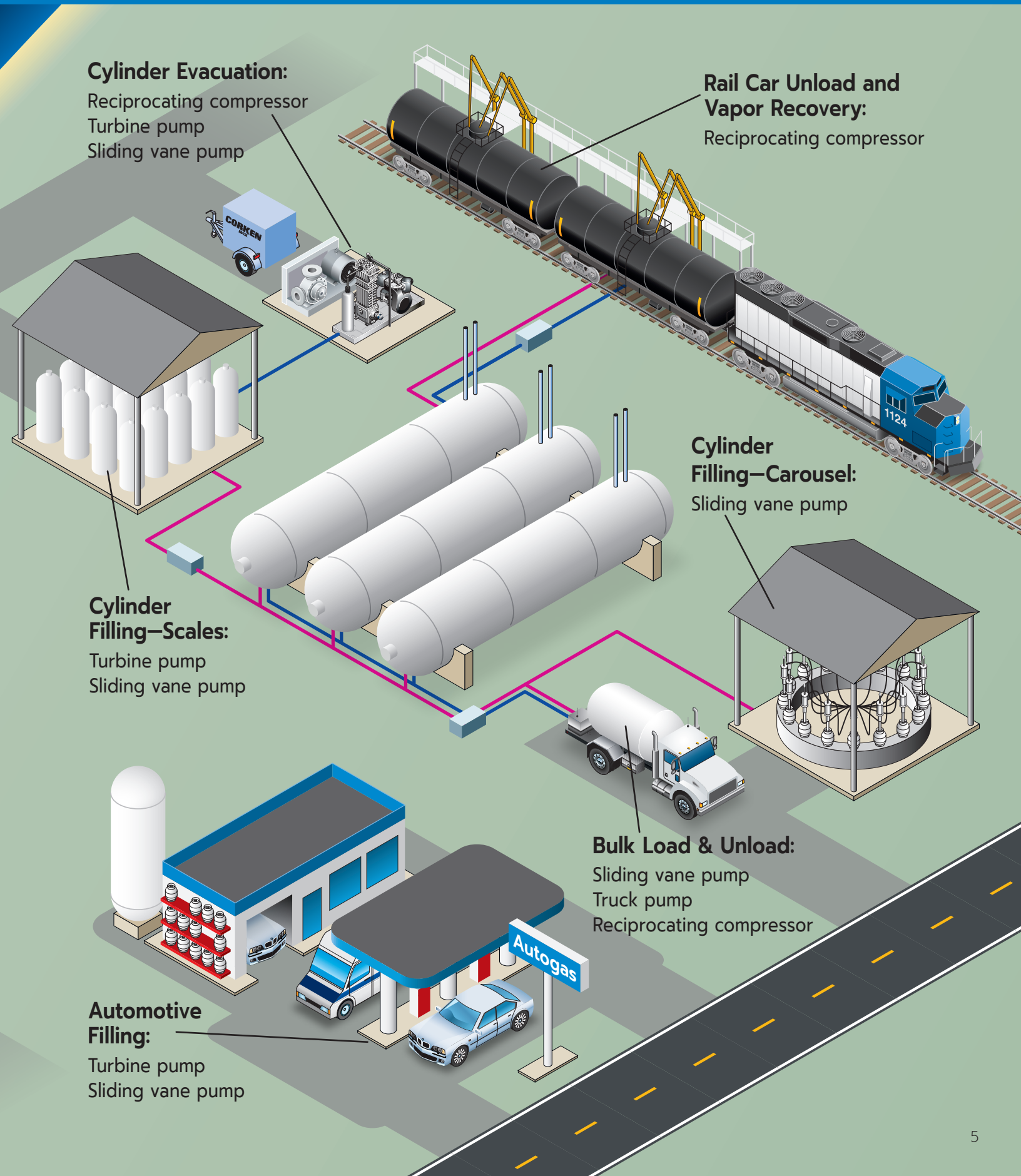

Regenerative Turbine Pumps Features and Benefits

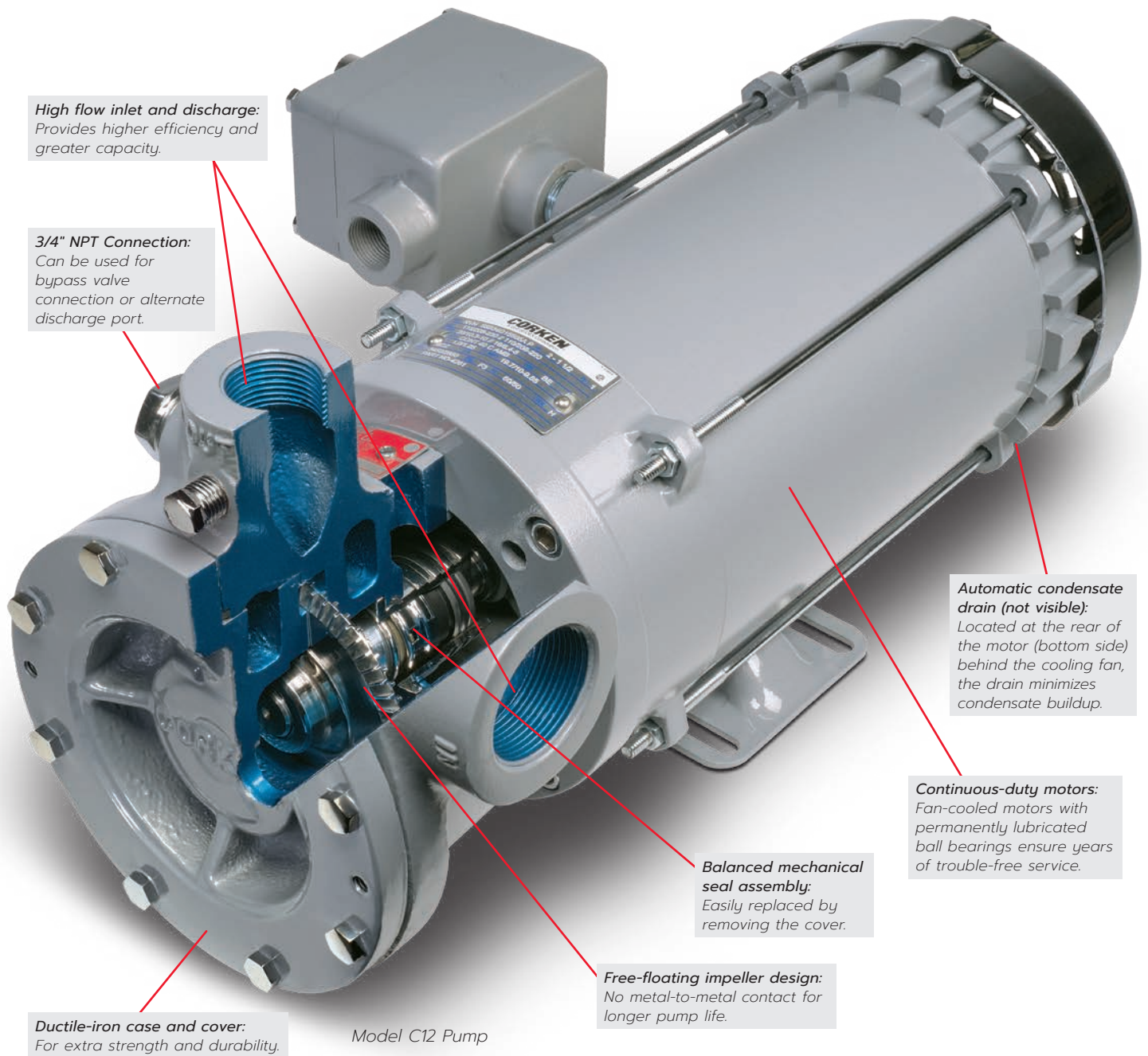

High flow inlet and discharge:
Provides higher efficiency and greater capacity.

3/4" NPT Connection:
Can be used for bypass valve connection or alternate discharge port.

Ductile-iron case and cover:
For extra strength and durability.

Model C12 Pump

Balanced mechanical seal assembly:
Easily replaced by removing the cover.

Free-floating impeller design:
No metal-to-metal contact for longer pump life.

Automatic condensate drain (not visible):
Located at the rear of the motor (bottom side) behind the cooling fan, the drain minimizes condensate buildup.

Continuous-duty motors:
Fan-cooled motors with permanently lubricated ball bearings ensure years of trouble-free service.

Smooth, quiet design...

The Coro-Flo® pump is designed for low-capacity, medium-head pumping. Since the impeller is the only moving part, the Coro-Flo is extremely quiet and free of vibration and pulsation. Additionally, the impeller is a free-floating so there is no contact with the pump case or head. This feature offers smooth continuous flow and years of trouble-free service.

Simple to service...

Simplicity of inspection and service is a key feature of the Coro-Flo®. With the cover removed, the impeller and seal can be serviced without disturbing the piping system. The balanced mechanical seal comes with its own sleeve; together they provide extremely reliable service.

Vaporizer Feed, Cylinder, and Automotive Filling

Equipped with an automatic condensate drain...

Since intermittent duty may cause condensate to form inside the motor, all electrical motors for the Coro-Flo C-model pumps are equipped with a condensate drain at the rear of the motor. This feature minimizes damage to the motor due to excessive condensate buildup.

Suitable for many applications...

All Coro-Flo® pumps are listed by Underwriters' Laboratories, Inc. for use in LP-Gas and anhydrous ammonia service.

Although the Coro-Flo® was originally designed to fill propane cylinders, its highly versatile design found its way into many other liquefied gases such as NH₃, CO₂, SO₂, and refrigerants. Other applications include vaporizer feed, aerosol filling systems, and moving condensate.

Specifications and Performance

Specifications	Model				
	10	12	13	14	16
Inlet	1-1/4" NPT	1-1/2" NPT	1-1/2" NPT	1-1/2" NPT	1-1/4" NPT
Outlet	1" NPT	1" NPT	1" NPT	1" NPT	1" NPT
RPM—50 Hz	2,880	2,880	2,880	2,880	2,880
RPM—60 Hz	3,450	3,450	3,450	3,450	3,450
Maximum differential pressure					
2880 RPM @ 50 Hz, psi (bar)	60 (4.1)	75 (5.2)	75 (5.2)	75 (5.2)	150 (10.3)
3450 RPM @ 60 Hz, psi (bar)	70 (4.8)	100 (6.9)	125 (8.6)	125 (8.6)	175 (12.1)
Mounting options					
Close coupled	Yes	Yes	Yes	Yes	Yes
Direct driven (101)	Yes	Yes	Yes	Yes	Yes
V-belt (103)	Yes	Yes	Yes	Yes	Yes
Direct mounted frame (DL)	Yes	Yes	Yes	Yes	Yes
Impeller material options	Bronze (standard), ductile iron, stainless steel				
O-ring material options	Buna-N (standard), Kalrez ^{®1} , Neoprene ^{®1} , PTFE, Viton ^{®1} , ethylene-propylene				
Seal seat material	Silicon carbide				
Minimum/maximum temperature °F (°C)	-25/225 (-32/107)	-25/225 (-32/107)	-25/225 (-32/107)	-25/225 (-32/107)	-25/225 (-32/107)
Maximum driver hp (kW)	5 (3.7)	10 (7.5)	10 (7.5)	20 (15)	20 (15)

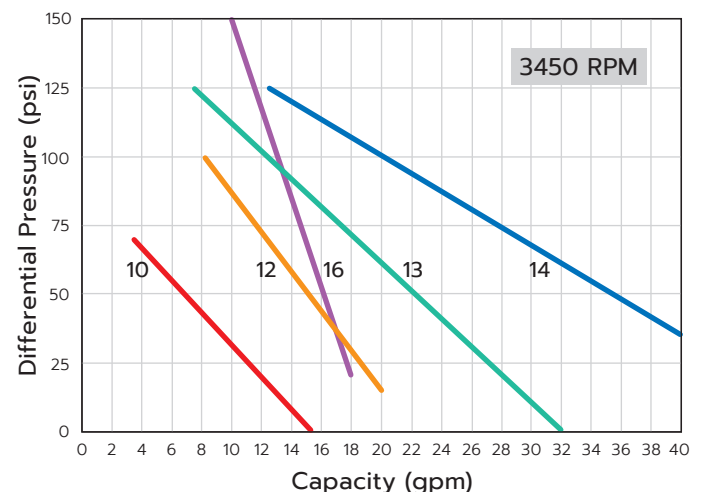
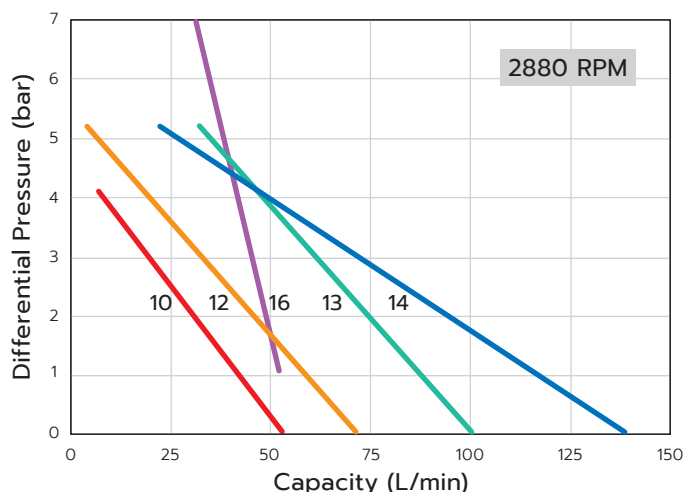

Performance curves are based on aboveground LPG installations. Performance curves for underground LPG tanks will vary based on the specific installation.

¹ Registered trademark of the DuPont Company.

Regenerative Turbine Pumps Features and Benefits

High strength metric fasteners.

Case and cover are ASTM A536 ductile iron, providing maximum thermal shock protection.

Self-aligning, free-floating, precision machined impeller, incorporating proprietary design, optimizes flow and provides quiet non-pulsating transfer of LPG.

Maximum sealing provided by a single balanced, precision lapped, mechanical seal.

By simply removing the cover, the seal can be replaced in minutes.

Class 300 RF flange and DIN (300 lb.) flanges provide optimal leak control and enhances structural integrity.

Pressure gauge connections help simplify analysis of system performance.

Heavy-duty ball bearings are rated for continuous duty service and provide maximum life.

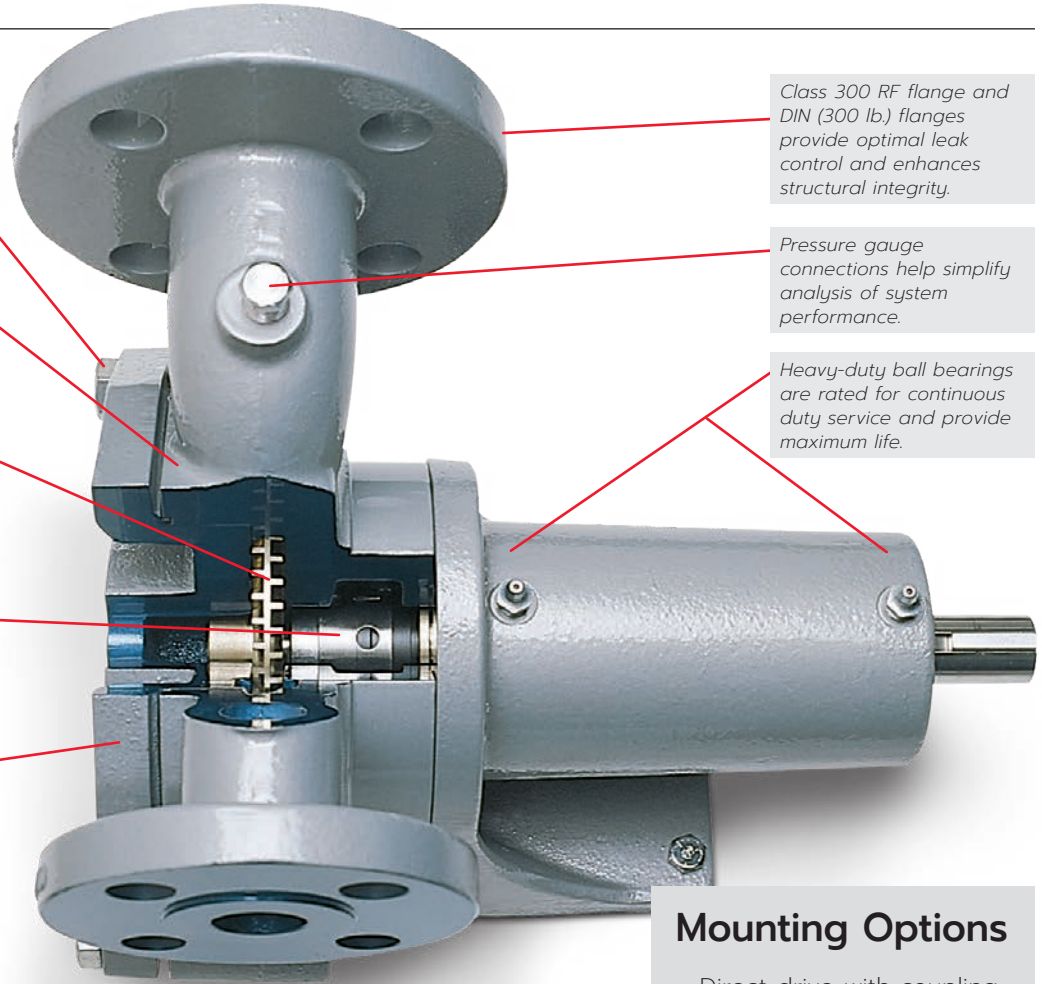

Model FF150 Pump

Mounting Options

- Direct drive with coupling
- Belt drive
- Direct mounted with C-face electric motor

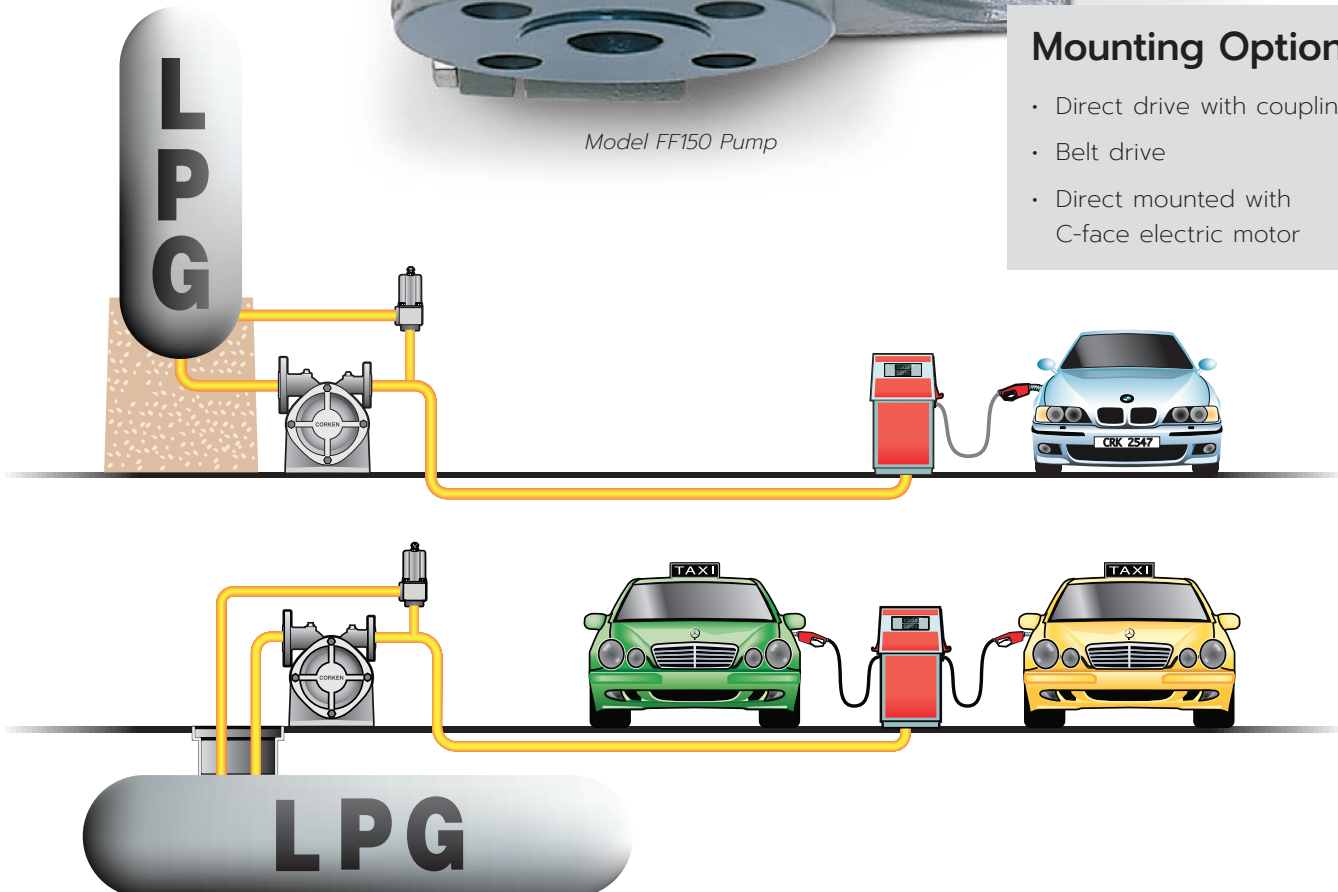

For High Differential Pressure Applications

Specifications and Performance

Specifications	All Models 075 and 150
Inlet flange	1-1/2" - Class 300 RF flange or DIN 300 lb. (optional)
Outlet flange	1" - Class 300 RF flange or DIN 300 lb. (optional)
RPM	3450 at 60 Hz or 2880 at 50 Hz
Maximum working pressure	27.6 bar (400 psig)
Maximum differential pressure ¹	Model 075: 13.8 bar (200 psig) at 60 Hz Model 150: 17.2 bar (250 psig) at 60 Hz
Flow range	Model 075: 8.5–40 (32.2–151.4 L/min) Model 150: 11–60 (41.6–227.1 L/min)
Maximum/minimum temperature	107°C (225°F) / -32°C (-25°F)
Impeller material	Bronze (standard)
O-ring material	Buna-N (standard)
Seal seat material	Silicon carbide (standard)
Maximum driver	15 kW (20 hp)
Type of electric motor ²	Rigid-base (frame mount) and C-face (direct mount)

Other Applications

- Cylinder filling
- Vaporizer feed
- Bulk transfer
- Direct burner feed
- Aerosol propellant

Model 075 Coro-Flo® Pump³

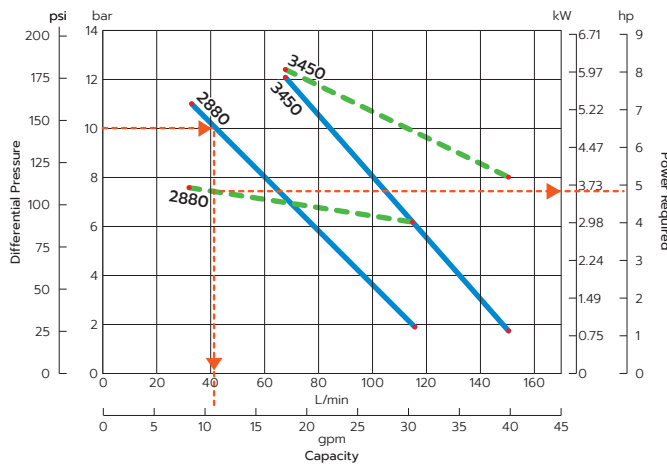

2880 RPM @ 50 Hz		
Differential pressure:	Flow:	Power required:
10.0 bar	42 L/min	3.65 kW
145.0 psi	11 gpm	4.9 hp
Curves based on LPG³		
Capacity	Power required	

Model 150 Coro-Flo® Pump³

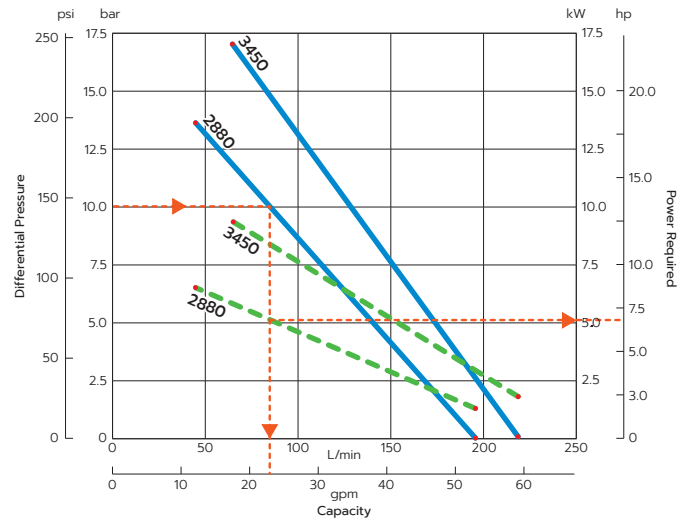

2880 RPM @ 50 Hz		
Differential pressure:	Flow:	Power required:
10.0 bar	85 L/min	5.1 kW
145.0 psi	22.5 gpm	6.8 hp
Curves based on LPG³		
Capacity	Power required	

¹ Maximum discharge pressure should be limited to the maximum system pressure rating.

² Consult factory regarding other types of motors.

³ The performance curves are based on above-ground LPG installations. Performance curves for underground LPG tanks will vary based on the specific installation. Consult factory.

Sliding Vane Pumps Features and Benefits

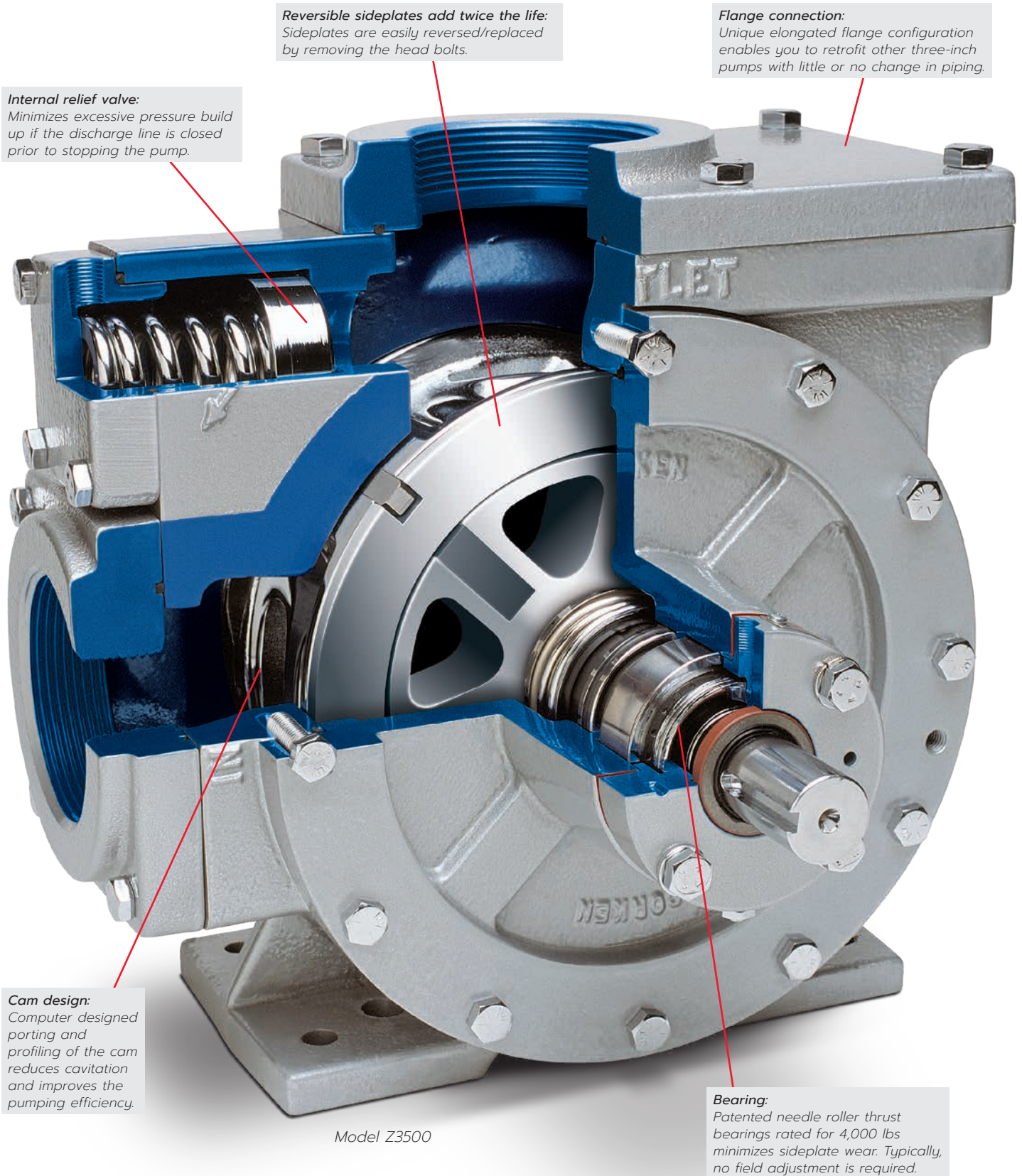

Bulk Filling, Carousel Filling, and Cylinder Filling

High pumping efficiencies...

Since the pumping efficiencies remain high throughout the life of a positive displacement, sliding vane pump, they are commonly used in the LPG industry. The Coro-Vane® is unique because it can handle small amounts of vapor formed at the suction side and the vanes self-adjust for wear. These design characteristics make the Coro-Vane well suited for LPG and anhydrous ammonia applications.

Maintenance made simple...

The pump casing and rotor are constructed of high strength ductile iron. For maximum longevity, all Z-Series pumps have a replaceable casing liner and reversible sideplates. By simply removing the head assembly, the casing liner, vanes, and seal assembly can be replaced in minutes.

Wide range of capacities...

Corken manufactures three sizes of stationary pumps ranging from 20 to 382 gpm (75.7 to 1,446 L/min). Each pump is available with a V-belt or direct-drive mounting option.

Model Z2000: The model Z2000 (2" NPT) is a foot mounted stationary pump designed for smaller plant applications such as cylinder filling and bulk filling. In some regions of the world, the model Z2000 doubles as a truck pump.

Model Z3500: The model Z3500 (3" NPT) is a foot mounted stationary pump but doubles as a truck pump in some regions of the world. It is well suited for medium sized applications such as bulk filling and loading and unloading up to two bobtail trucks. Additionally, the Z3500 is a bolt-in replacement for Corken's model 1021 pump so no piping modifications are necessary.

Model Z4500: The model Z4500 (4" Class 300 RF flange) is a stationary pump designed for large loading and unloading applications. When using two or more bulkheads to load transports or multiple bobtails, the Z4500 can shorten the fill times.

To protect the pump from excessive pressure buildup, all of the Z-Series stationary pumps are equipped with a built-in internal relief valve. In the event the discharge

line is closed prior to stopping the pump, the internal relief valve releases excessive pressure in the discharge line back to the suction side allowing the liquid to circulate through the pump. The internal relief valve does not replace the external bypass valve. In order to comply with NFPA and UL requirements, all pumps must have an external bypass valve.

Specifications and Performance

Specifications	Model		
	Z2000	Z3500	Z4500
Inlet flange	2" NPT	3" NPT	4" Class 300 RF flange
Outlet flange	2" NPT	3" NPT	3" Class 300 RF flange
Minimum RPM	420	420	420
Maximum RPM	780	800	800
Minimum temperature	-25°F (-32°C)		
Maximum temperature	225°F (107°C)		
Maximum working pressure: psig (bar)	400 (28.6)	400 (28.6)	400 (28.6)
Maximum differential pressure: psig (bar)	125 (8.6)	125 (8.6)	125 (8.6)
Internal relief	Yes	Yes	Yes
O-ring material options:	Buna-N (standard), PTFE, Viton® ¹ , Neoprene® ¹		
Seal seat material:	Silicon Carbide		
Inlet flange option	Yes	Yes	No
Outlet flange option	Yes	Yes	No
Maximum driver: hp (kW)	10 (7.5)	20 (15.0)	25 (18.5)

¹ Registered trademark of the DuPont company.

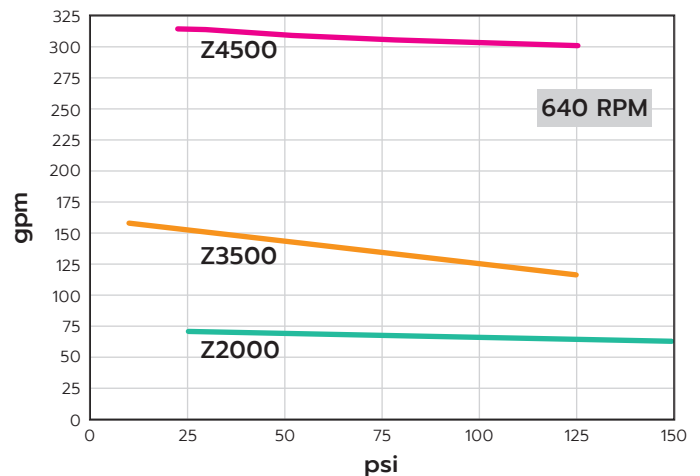

Reciprocating Gas Compressors Features and Benefits

Connections:

Available in threaded NPT or Class 300 RF flanges.

High-efficiency valves:

Valves are quiet and highly durable. Special suction valves tolerating small amounts of condensate are available.

O-ring seals:

Easy to install O-ring seals head and cylinder.

Ductile iron construction:

Cylinder and head are made of ductile iron for maximum thermal shock endurance.

Self-lubricating PTFE piston rings:

State-of-the-art piston ring designs to provide the most cost-effective operation of compressors for non-lube service. The step-cut design provides higher efficiencies during the entire life of the piston ring.

Positively locked piston:

Simple piston design allows end clearance to be precisely set to provide maximum efficiency and long life.

Piston rod seals:

Seals constructed of PTFE incorporating special fillers to maximize leakage control. Spring loaded seal design self adjusts to compensate for normal wear.

Nitrotec® coated piston rods:

Impregnated nitride coating provides superior corrosion and wear resistance.

Cast-iron crosshead:

Durable cast-iron crossheads provide superior resistance to corrosion and galling.

Pressure-lubricated crankcase with filter:

Self-reversing oil pump ensures proper lubrication regardless of directional rotation to main and connecting rod bearings. Standard 10-micron filter ensures long-lasting bearing life (not available on Model 91).

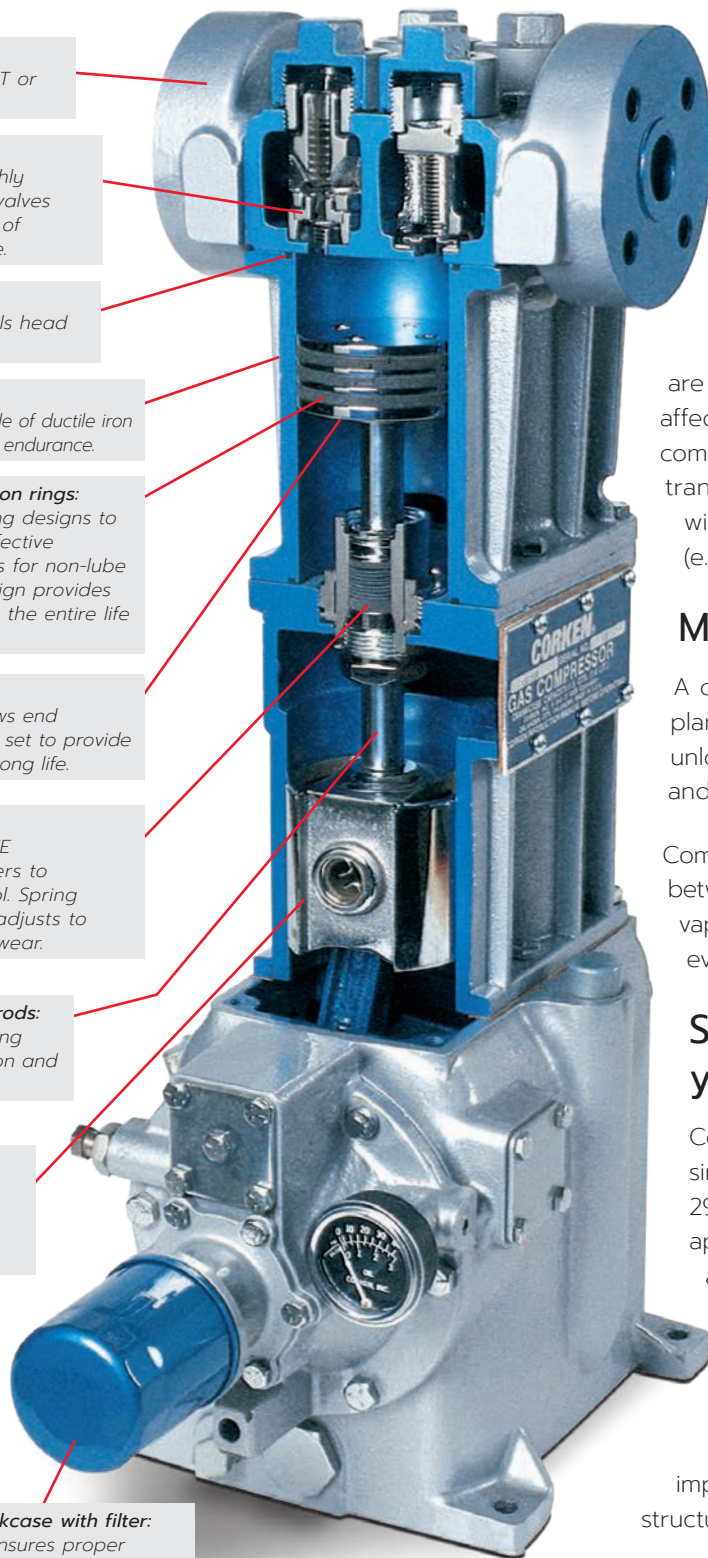

Model F291
(single acting)

Why select a compressor to transfer LPG and NH₃?

Many LPG piping systems do not provide ideal NPSH conditions for liquid pumps. As a result, the poor NPSH conditions lead to excessive pump maintenance. Since compressors are only exposed to vapors, they are not affected by poor NPSH conditions. A compressor is the perfect solution for transferring liquids to and from tanks with unloading connections on the top (e.g. tank cars and underground tanks).

Maximum versatility...

A compressor can be piped for multiple plant applications. Many times a tank car unloading compressor is utilized to load and unload trucks as well.

Common applications include liquid transfer between tanks, off-load/load-out liquids, vapor recovery, and performing tank evacuation for maintenance purposes.

Several models to match your needs...

Corken offers five sizes of vertical, single-stage compressors (Models 91, 291, 491, 691, and 891) for LPG/NH₃ applications. The compressors are available with threaded NPT or Class 300 RF flanged connections and

cover a full range of capacities ranging from 4.1 to 117 cfm (7.0 to 198.8 m³/hr) of liquid transfer. The

Class 300 RF flange dramatically improves leakage containment and structural integrity.

Piston rod packing design...

Corken's standard LPG vertical compressors are a plain style design using one set of V-ring packing. Most

¹ Registered trademark of TTI Group Ltd.

Cylinder Evacuation, Bulk Transfer, and Recovery

of Corken's LPG vertical compressors use a single set of V-ring packing (plain-style). The only exception is the model 891 which uses a combination of V-ring packing and segmented packing. Even though the model 891 is a D-style compressor, it is the only D-style compressor that is not oil free. All other D-style compressors are oil free.

V-ring packing consists of several V-rings, male and female packing rings, washers, and a spring while segmented packing consists of packing cups, spacers, O-rings, segmented packing, backup rings, and a spring. None of the plain style packing arrangements are oil-free designs. If oil-free gas compression is required, Corken's D- or T-style compressors are recommended.

Single-stage design...

Corken's single-stage compressors are typically used in applications where the gas compression ratio is less than 5:1. Generally, applications with relatively low differential pressures are well suited for a single-stage compressor. Transport, rail car, and marine unloading by vapor differential are examples of this type of application.

Single-acting designs with a wide range of capacities...

Single-acting vertical compressors only have one compression stroke per revolution so the compression takes place on one side (top) of the piston. Single-acting compressors come in a variety of models. Cylinder sizes range from 3.0" to 4.5" (76.2 to 114.3 mm) while piston displacement ranges from 4.1 to 60.8 cfm (7.0–103.3 m³/hr).

Double-acting design for even greater capacity...

Double-acting compressors have two compression strokes per revolution so the compression takes place on both sides of the piston. As a result, double-acting compressors offer greater capacities. Corken's model 891 is a double-acting single-stage gas compressor supplying between 56.7 and 117.0 cfm (96.3 and 198.8 m³/hr). The model D891/FD891 is offered in either lubricated or non-lubricated versions and is not an oil-free design; however, the T891 (T-style) compressor does offer oil-free gas compression.

Maintenance made simple...

Corken compressors are designed to simplify routine maintenance procedures. Maintenance operations such as valve replacement may be accomplished without disturbing the piping, while ring replacement may be accomplished simply by removing the head.

Designed for a variety of applications...

Corken gas compressors are designed for use in liquid transfer, vapor recovery, scavenger, and portable applications. Whether it is gas recovery from cylinders or barge unloading, Corken has a compressor to fit the application.

Custom engineered compressor packages available...

Corken offers standard mountings designed specifically for liquefied gas transfer, vapor recovery, and gas booster applications. If they do not meet the specifications of the application, Corken can supply a custom engineered package. Skid mounted units are supplied with control panels, safety controls, pulsation dampeners, receiver tanks, valves, and other special accessories as required. For more details, see the standard compressor mountings and custom engineered packages at the back of this sales brochure.



Model D891
(double acting)



Model 491
(single acting)

Reciprocating Gas Compressors Features and Benefits

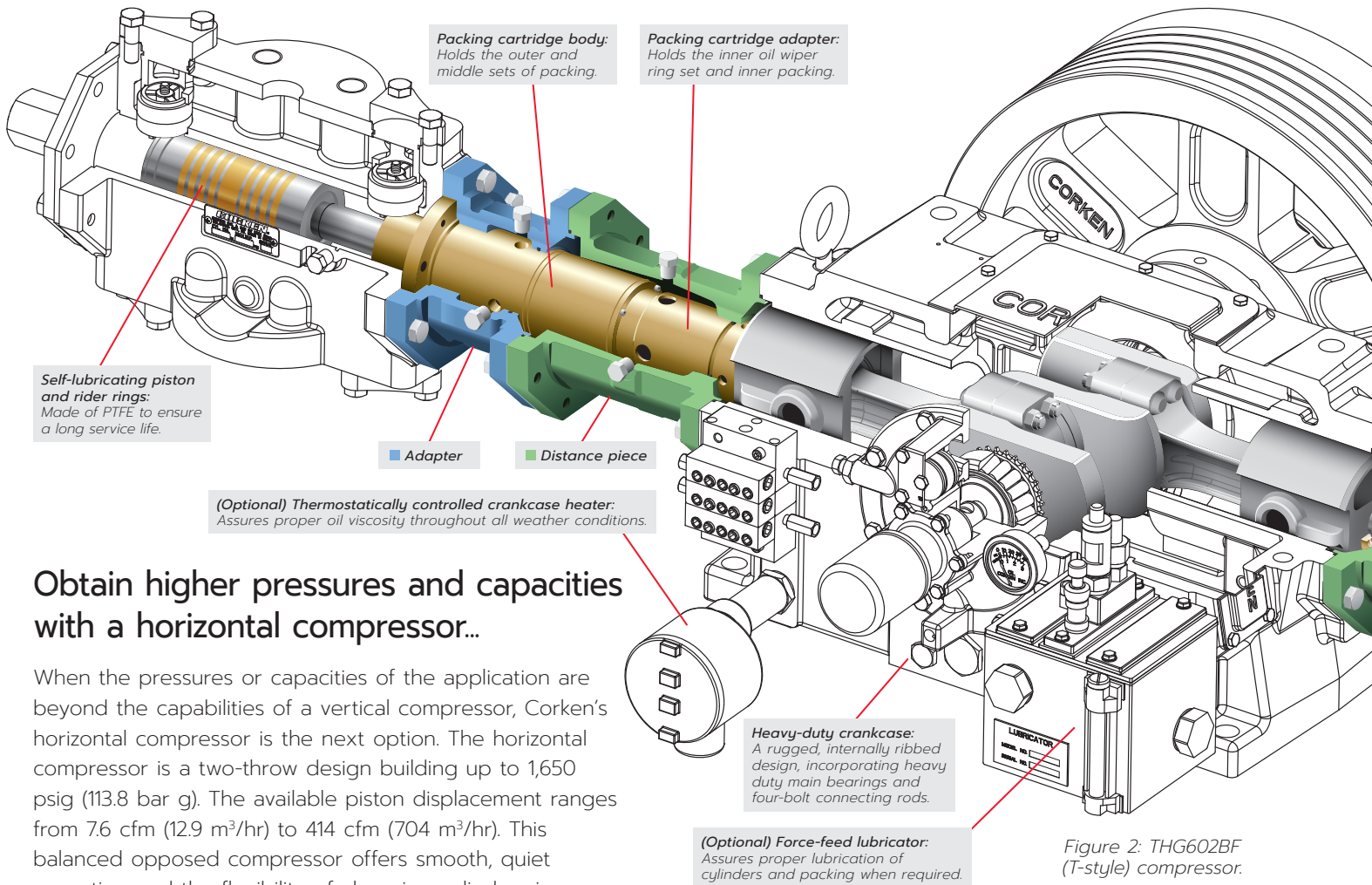

Obtain higher pressures and capacities with a horizontal compressor...

When the pressures or capacities of the application are beyond the capabilities of a vertical compressor, Corken's horizontal compressor is the next option. The horizontal compressor is a two-throw design building up to 1,650 psig (113.8 bar g). The available piston displacement ranges from 7.6 cfm (12.9 m³/hr) to 414 cfm (704 m³/hr). This balanced opposed compressor offers smooth, quiet operation and the flexibility of changing cylinder sizes as needed to optimize the compressor for the desired operating conditions. Cylinder sizes are 8" (203.2 mm), 6" (152.4 mm), 5" (127.0 mm), 4" (101.4 mm), 3.25" (82.6 mm), 2.75" (69.9 mm), and can be arranged in various single-stage and two-stage configurations. Lubricated, non-lubricated, and oil-free versions are available.

Available in two styles...

Corken offers two styles of horizontal compressors: plain style and T-style. The plain style (HG600 series) has one set of packing per piston rod while the T-style (THG600 series) has three sets of packing per piston rod.

Use a single-packed, plain style for standard leakage containment...

The plain style (HG600 series) horizontal compressor is not oil free and only has one set of packing. This packing

configuration is typically used in non-corrosive, non-toxic services where oil-free gas is not required and leakage containment is not critical. Some examples are LPG, oilfield applications (natural gas), and air boosting applications.

Use a triple-packed, T-style for maximum leakage containment...

The T-style (THG600 series) is a non-lubricated, oil-free design with three sets of packing that form two distance pieces or barriers to external leakage (see figure 2 for details). For a wide range of application flexibility, each distance piece has its own line connections that can be pressurized, purged, or vented separately. This allows the operator to choose the best method of containment for the application. When properly equipped with a purge kit, Corken's double-distance piece (T-style) provides precise leakage control and complies with the EPA's

Tanker and Multiple Railcar Unloading and Recovery

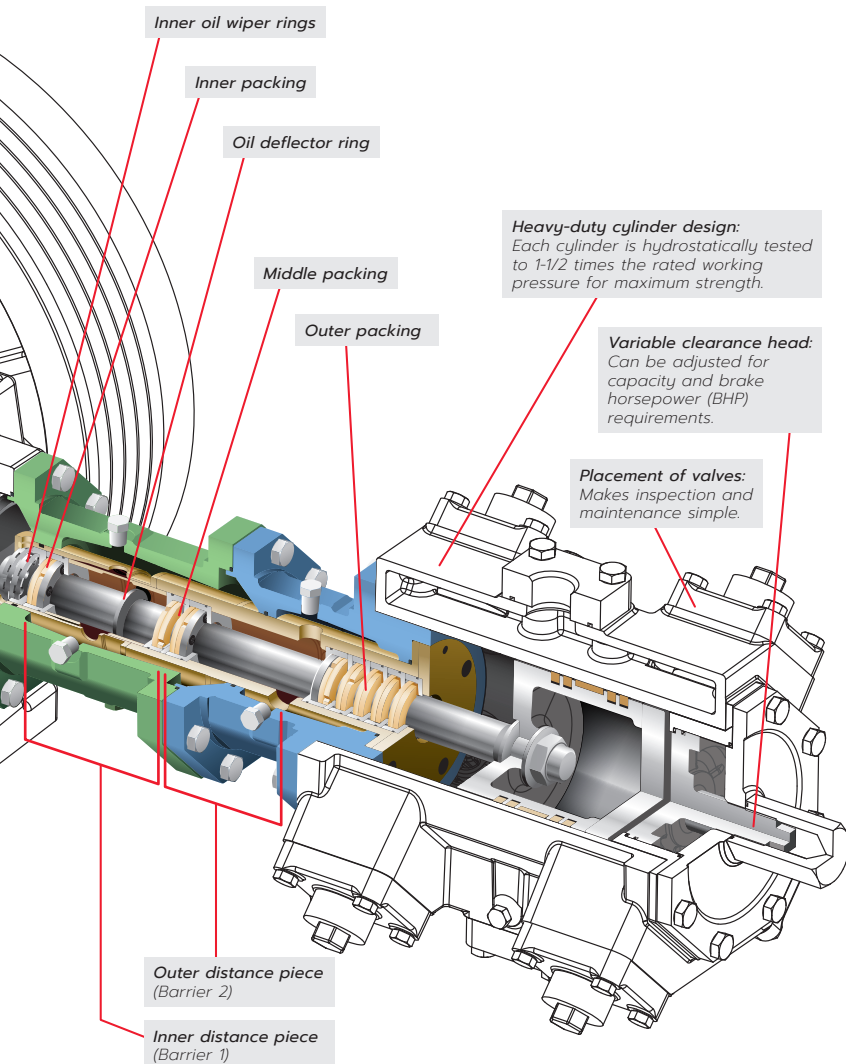

requirements* for fugitive emissions control of volatile organic compounds (VOC). For added convenience, purge kits with all of the accessories needed to control the purging or pressurization of each chamber are available. T-styles are typically used in corrosive or toxic applications where leakage containment and non-contamination of the gas stream are critical.

**U.S. Environmental Protection Agency Regulations 40 CFR CH Section 264.1053.*

Piston rod packing design...

Unlike Corken's vertical compressor, the horizontal compressor uses segmented purge packing to seal the piston rod. Segmented purge packing consists of purge packing cups, spacers, O-rings, segmented packing, backup rings, and springs.

Oil-free gas compression...

Corken's T-style (double-distance piece) horizontal compressors are oil free so there's no contamination of the process gas stream. The T-style has three sets of segmented packing. Since the distance between each set of packing is greater than the stroke of the compressor, there's no rod over travel or oil carryover. In other words, the portion of the piston rod coming into contact with the first set of packing will never reach the second set of packing while the portion of the piston rod coming into contact with the second set of packing will never reach the third set of packing. In the event oil gets past the inner packing set, the oil deflector ring keeps it from reaching the outer distance piece (see figure 2 for details).

Available in single- or double-acting configurations...

The plain and T-style horizontal compressors are available in single- or double-acting configurations. Single-acting configurations are ideal for applications requiring low flow and high pressure while double-acting configurations offer maximum capacity. Single-acting configurations require a blank valve option.

External crankcase oil cooler...

Corken's industrial compressors are equipped with a force-feed-lubrication system and external oil filter. For high horsepower applications, Corken recommends an optional external oil cooler. This will ensure a consistent oil temperature and an optimal service life for the compressor.

Custom engineered compressor packages available...

Corken offers standard mountings designed specifically for liquefied gas transfer, vapor recovery, and gas booster applications. If they do not meet the specifications of the application, Corken can supply a custom engineered package. Skid mounted units are supplied with control panels, safety controls, pulsation dampeners, receiver tanks, valves, and other special accessories as required. For more details, see the standard compressor mountings and custom engineered packages at the back of this sales brochure.

Reciprocating Gas Compressors Vertical

Operating Specifications

Specifications	Model				
	91/F91	291/F291	491/F491	691/F691	D891/FD891 ^a
Bore of cylinder: inches (mm)	3.0 (76.2)	3.0 (76.2)	4.0 (101.6)	4.5 (114.3)	4.5 (114.3)
Stroke: inches (mm)	2.5 (63.5)	2.5 (63.5)	3.0 (76.2)	4.0 (101.6)	4.0 (101.6)
Piston displacement cfm (m ³ /hr)					
minimum @ 400 RPM	4.1 (7.0)	8.2 (13.9)	17.5 (29.7)	29.5 (50.1)	56.7 (96.3)
maximum @ 825 RPM	8.4 (14.3)	16.9 (28.7)	36.0 (61.2)	60.8 (103.3)	117 (198.8)
Maximum working pressure: psig (bar g)	335 (23.1)	335 (23.1)	335 (23.1)	335 (23.1)	450 (31.0)
Maximum brake horsepower: hp (kW)	7.5 (5.6)	15 (11)	15 (11)	35 (26.1)	45 (34)
Maximum rod load: lb (kg)	3,600 (1,633)	3,600 (1,633)	4,000 (1,814)	7,000 (3,175)	7,000 (3,175)
Maximum outlet temperature: °F (°C)			350 (177)		
Minimum inlet temperature: °F (°C)			-25 (-32)		
Bare unit weight: lb (kg)	150 (68.0)	210 (95.2)	390 (176.9)	745 (337.9)	900 (408.2)
Maximum flow-propane: gpm (m ³ /hr)	50 (11.4) ^b	101 (22.9) ^b	215 (48.8) ^b	361 (82.0) ^b	694 (157.6) ^b
Class 300 RF flange/DIN flange option	Yes	Yes	Yes	Yes	No

^aDouble-acting vertical compressor.

^bMaximum flow is based on 825 RPM or maximum hp, 30 psid. Capacities shown are based on 100°F (37.8°C) and will vary depending upon piping, fittings, product being transferred, and temperature. The factory will supply a detailed compressor analysis if required.

33,000 Gallon (124,918 Liter) Tank¹

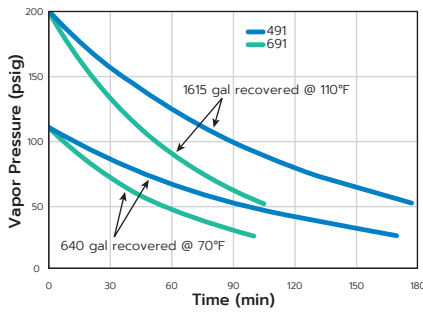

10,000 Gallon (37,854 Liter) Tank¹

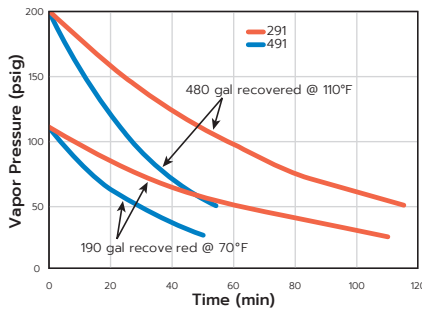

1,000 Gallon (3,785 Liter) Tank¹

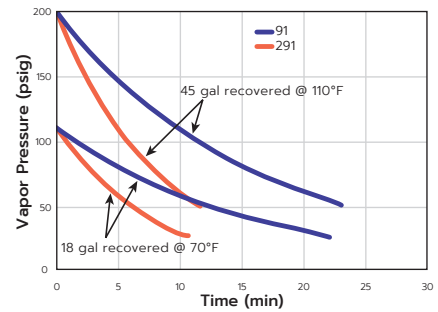

Performance (Propane)¹

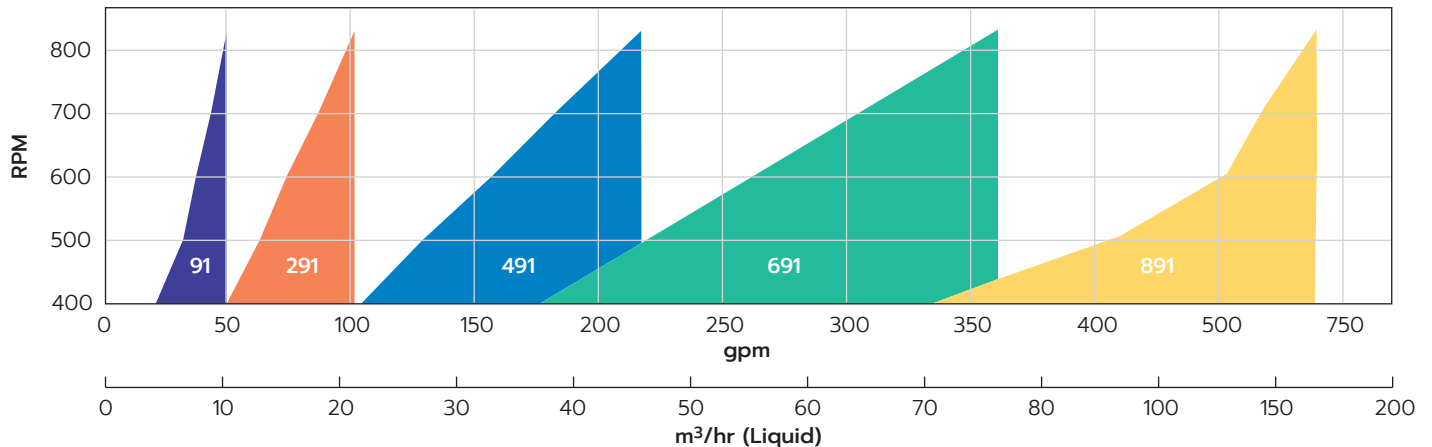

¹ Capacities shown are based on 100°F (37.8°C) and will vary depending upon piping, fittings, product being transferred, and temperature. The factory will supply a detailed compressor analysis if required.

Reciprocating Gas Compressors Horizontal

Operating Specifications

Single Cylinder Models	HG601AX THG601AX	HG601BX THG601BX	HG601CX THG601CX	HG601DX THG601DX	HG601EX THG601EX	HG601FX THG601FX
Size	8"	6"	5"	4"	3.25"	2.75"
Displacement: cfm (m ³ /hr)						
400 rpm	68.8 (116.9)	38.4 (65.2)	26.4 (44.9)	16.8 (28.5)	10.8 (18.3)	7.6 (12.9)
1200 rpm	207.0 (351.7)	115.0 (195.4)	79.2 (134.4)	49.8 (84.6)	32.2 (54.5)	22.8 (56.0)
Approximate shipping weight: lb. (kg.)						
HG model	730 (331.1)	650 (295.0)	640 (290.3)	630 (285.8)	620 (281.2)	620 (281.2)
THG model	780 (353.8)	700 (317.5)	690 (313.0)	680 (308.4)	670 (303.9)	670 (303.9)
Two Cylinder Models	HG601AA THG601AA	HG601BB THG601BB	HG601CC THG601CC	HG601DD THG601DD	HG601EE THG601EE	HG601FF THG601FF
Size	8" x 8"	6" x 6"	5" x 5"	4" x 4"	3.25" x 3.25"	2.75" x 2.75"
Displacement cfm (m ³ /hr)						
400 rpm	138 (234.5)	76.8 (130.5)	52.8 (89.7)	33.2 (56.4)	21.2 (36.0)	14.8 (25.1)
1200 rpm	414 (704)	231 (393)	158.4 (268.8)	99.6 (169.2)	64 (108.7)	44.4 (75.6)
Approximate shipping weight: lb. (kg.)						
HG model	1,070 (485.4)	910 (412.8)	890 (403.7)	870 (394.6)	845 (383.3)	845 (383.3)
THG model	1,170 (530.7)	1,010 (458.1)	990 (449.1)	970 (440.0)	945 (428.7)	945 (428.7)

Cylinder Data

Description	Cylinder Code					
	A	B	C	D	E	F
Cylinder bore: in. (mm)	8 (203.2)	6 (152.4)	5 (127)	4 (101.6)	3.25 (82.6)	2.75 (69.9)
Maximum working pressure: psig (bar g)	300.0 (20.7)	350 (24.1)	750 (51.7)	1,000.0 (69.0)	1,200.0 (82.8)	1,650.0 (113.8)

Frame Data

Stroke: inches (mm)	3.0 (76.2)
Maximum gas rod load: lb (kg)	7,000 (3,175.2)
Maximum motor size: hp (kW)	75 (55.9)
Maximum discharge temperature: °F (°C) ¹	350 (177)
Minimum temperature: °F (°C)	-25 (-32)
RPM range	400 - 1,200

Performance (Propane)²

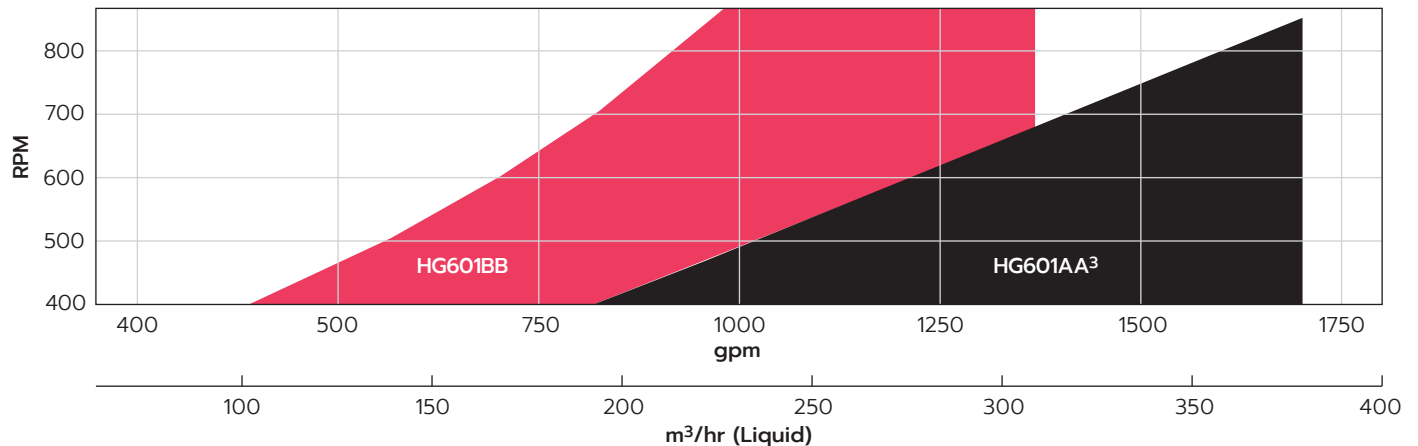

¹ 350°F discharge temperature requires use of high temperature O-rings, such as PTFE or Viton®. Maximum recommended discharge temperature for use with Buna-N or Neoprene® O-rings is 250°F. Viton and Neoprene are registered trademarks of the DuPont company.

² Capacities shown are based on 100°F (37.8°C) and will vary depending upon piping, fittings, product being transferred, and temperature. The factory will supply a detailed compressor analysis if required.

³ Maximum 75 hp is reached at 845 RPM.

Propane Compressor Selection Table

Service	Capacity ¹	Displacement cfm	Compressor		Driver Sheave Size P.D." ²		Driver Horsepower				Piping Size ³	
							Liquid Transfer and Residual Vapor Recovery		Liquid Transfer without Residual Vapor Recovery			
							100°F	80°F	100°F	80°F		
Small bulk plants	23	4	91	400	A 3.0	B 3.6	5	3	3	3	3/4	1-1/4
	29	5	91	505	B 3.8	B 4.6	5	5	5	5	3/4	1-1/4
	34	6	91	590	B 4.6	B 5.6	5	5	5	5	1	1-1/4
	40	7	91	695	B 5.4	B 6.6	5	5	5	5	1	1-1/2
	39	7	291	345	A 3.0	A 3.6	3	3	3	3	1	1-1/2
Unloading single tank car or transport	45	8	91	800	B 6.2	B 7.4	7-1/2	7-1/2	7-1/2	7-1/2	1	1-1/2
	44	8	291	390	A 3.4	B 4.0	5	3	3	3	1	1-1/2
	50	9	291	435	A 3.8	B 4.6	5	5	3	3	1	1-1/2
	56	10	291	490	B 4.4	B 5.2	5	5	5	5	1	2
	61	11	291	535	B 4.8	B 5.8	5	5	5	5	1	2
	66	12	291	580	B 5.2	B 6.2	7-1/2	5	5	5	1	2
	71	13	291	625	B 5.6	B 6.6	7-1/2	5	7-1/2	5	1-1/4	2
	79	14	291	695	B 6.2	B 7.4	7-1/2	7-1/2	7-1/2	7-1/2	1-1/4	2
	84	15	291	735	B 6.6	B 8.0	10	7-1/2	10	7-1/2	1-1/4	2-1/2
	84	15	491	345	A 3.0	A 3.6	7-1/2	7-1/2	5	5	1-1/4	2-1/2
	89	16	291	780	B 7.0	B 8.6	10	10	10	10	1-1/4	2-1/2
89	16	491	370	A 3.2	A 3.8	7-1/2	7-1/2	7-1/2	5	1-1/4	2-1/2	
Unloading two or more tank cars at one time or large transport with excess flow valves of adequate capacity	95	17	491	390	A 3.4	B 4.0	7-1/2	7-1/2	7-1/2	7-1/2	1-1/4	3
	101	18	491	415	A 3.6	B 4.4	10	7-1/2	7-1/2	7-1/2	1-1/4	3
	106	19	491	435	A 3.8	B 4.6	10	7-1/2	7-1/2	7-1/2	1-1/4	3
	108	20	491	445	B 4.0	B 4.8	10	7-1/2	7-1/2	7-1/2	1-1/4	3
	114	21	491	470	B 4.2	B 5.0	10	7-1/2	7-1/2	7-1/2	1-1/4	3
	119	22	491	490	B 4.4	B 5.2	10	10	7-1/2	7-1/2	1-1/4	3
	125	23	491	515	B 4.6	B 5.6	10	10	10	7-1/2	1-1/4	3
	130	24	491	535	B 4.8	B 5.8	15	10	10	10	1-1/4	3
	136	25	491	560	B 5.0	B 6.0	15	10	10	10	1-1/4	3
	141	26	491	580	B 5.2	B 6.2	15	10	10	10	1-1/4	3
	147	27	491	605	B 5.4	B 6.4	15	10	15	10	1-1/4	3
	152	28	491	625	B 5.6	B 6.6	15	15	15	15	1-1/2	3
	158	29	491	650	B 5.8	B 7.0	15	15	15	15	1-1/2	3
	163	30	491	670	B 6.0		15	15	15	15	1-1/2	3
	163	30	691	400	B 4.4	B 5.2	15	15	10	10	1-1/2	3
	168	31	491	695	B 6.2	B 7.4	15	15	15	15	1-1/2	3
	171	31	691	420	B 4.6	B 5.6	15	15	10	10	1-1/2	3
179	32	491	740	B 6.6	B 8.0	15	15	15	15	1-1/2	3	
178	32	691	440	B 4.8	B 5.8	15	15	10	10	1-1/2	3	
186	34	691	455	B 5.0	B 6.0	15	15	15	10	1-1/2	3	
193	35	691	475	B 5.2	B 6.2	15	15	15	10	1-1/2	3	
200	36	691	495	B 5.4	B 6.4	15	15	15	15	1-1/2	3	
Unloading large tank cars, multiple vessels, barges or terminals	208	38	691	510	B 5.6	B 6.8	20	15	15	15	1-1/2	4
	215	39	691	530	B 5.8	B 7.0	20	15	15	15	1-1/2	4
	223	41	691	550	B 6.0	A 7.0	20	15	15	15	1-1/2	4
	230	42	691	565	B 6.2	B 7.4	20	15	15	15	2	4
	237	43	691	585	B 6.4	A 7.4	20	15	15	15	2	4
	245	45	691	605	B 6.6	B 8.0	20	15	15	15	2	4
	252	46	691	620	B 6.8		20	20	15	15	2	4
	260	47	691	640	B 7.0	A 8.2	20	20	20	15	2	4
	275	48	691	675	B 7.4	B 8.6	25	20	20	20	2	4
	297	54	691	730	B 8.0	B 9.4	25	20	20	20	2	4
	319	58	691	785	B 8.6		25	20	25	20	2	4
	334	60	691	820	TB 9.0	A 10.6	30	25	25	20	2	4
	452	82	D/FD891	580	5V 7.1	5V 8.5	30	30	30	30	3	6
	623	113	D/FD891	800	5V 9.75	5V 11.8		40	40	30	3	6

¹ The capacities shown are based on 70°F, but will vary depending upon piping, fittings used, product being transferred and temperature. The factory can supply a detailed computer analysis if required.

² Driver sheaves: 91 - 2 belts; 291, 491 - 3 belts; 691 - 4 belts.

³ The piping sizes shown are considered minimum. If the length exceeds 100 ft., use the next larger size.

Consult factory for compressors with higher flows.

Ammonia Compressor Selection Table

Service	Capacity ¹	Displacement cfm	Compressor		Driver Sheave Size P.D." ²		Driver Horsepower				Piping Size ³	
							Liquid Transfer and Residual Vapor Recovery		Liquid Transfer without Residual Vapor Recovery			
							100°F	80°F	100°F	80°F		
Small bulk plants	23	4	91	400	A 3.0	B 3.6	5	3	3	3	3/4	1-1/4
	29	5	91	505	B 3.8	B 4.6	5	5	5	3	3/4	1-1/4
	34	6	91	590	B 4.6	B 5.6	5	5	5	5	1	1-1/4
	40	7	91	695	B 5.4	B 6.6	5	5	5	5	1	1-1/2
	43	7	291	345	A 3.0	A 3.6	5	3	3	3	1	1-1/2
Unloading single tank car or transport	46	8	91	800	B 6.2	B 7.4	7-1/2	5	5	5	1	1-1/2
	45	8	291	390	A 3.4	B 4.0	5	3	3	3	1	1-1/2
	50	9	291	435	A 3.8	B 4.6	5	5	3	3	1	1-1/2
	56	10	291	490	B 4.4	B 5.2	5	5	5	3	1	2
	62	11	291	535	B 4.8	B 5.8	7-1/2	5	5	5	1	2
	67	12	291	580	B 5.2	B 6.2	7-1/2	5	5	5	1	2
	72	13	291	625	B 5.6	B 6.6	7-1/2	5	5	5	1-1/4	2
	80	14	291	695	B 6.2	B 7.4	7-1/2	7-1/2	7-1/2	5	1-1/4	2
	85	15	291	735	B 6.6	B 8.0	10	7-1/2	7-1/2	7-1/2	1-1/4	2-1/2
	85	15	491	345	A 3.0	A 3.6	7-1/2	7-1/2	5	5	1-1/4	2-1/2
	90	16	291	780	B 7.0	B 8.6	10	7-1/2	7-1/2	7-1/2	1-1/4	2-1/2
90	16	491	370	A 3.2	A 3.8	10	7-1/2	5	5	1-1/4	2-1/2	
Unloading two or more tank cars at one time or large transport with excess flow valves of adequate capacity	96	17	491	390	A 3.4	B 4.0	10	7-1/2	5	5	1-1/4	3
	102	18	491	415	A 3.6	B 4.4	10	7-1/2	7-1/2	7-1/2	1-1/4	3
	107	19	491	435	A 3.8	B 4.6	10	7-1/2	7-1/2	7-1/2	1-1/4	3
	110	20	491	445	B 4.0	B 4.8	10	7-1/2	7-1/2	7-1/2	1-1/4	3
	115	21	491	470	B 4.2	B 5.0	10	7-1/2	7-1/2	7-1/2	1-1/4	3
	120	22	491	490	B 4.4	B 5.2	15	10	7-1/2	7-1/2	1-1/4	3
	126	23	491	515	B 4.6	B 5.6	15	10	7-1/2	7-1/2	1-1/4	3
	131	24	491	535	B 4.8	B 5.8	15	10	10	7-1/2	1-1/4	3
	138	25	491	560	B 5.0	B 6.0	15	10	10	7-1/2	1-1/4	3
	142	26	491	580	B 5.2	B 6.2	15	10	10	7-1/2	1-1/4	3
	148	27	491	605	B 5.4	B 6.4	15	10	10	10	1-1/4	3
	153	28	491	625	B 5.6	B 6.6	15	10	10	10	1-1/2	3
	160	29	491	650	B 5.8	B 7.0	15	15	10	10	1-1/2	3
	165	30	491	670	B 6.0		15	15	15	10	1-1/2	3
	165	30	691	400	B 4.4	B 5.2	15	15	10	10	1-1/2	3
	170	31	491	695	B 6.2	B 7.4	15	15	15	10	1-1/2	3
	173	31	691	420	B 4.6	B 5.6	15	15	10	10	1-1/2	3
181	32	491	740	B 6.6	B 8.0	15	15	15	15	1-1/2	3	
180	32	691	440	B 4.8	B 5.8	15	15	10	10	1-1/2	3	
188	34	691	455	B 5.0	B 6.0	20	15	10	10	1-1/2	3	
195	35	691	475	B 5.2	B 6.2	20	15	10	10	1-1/2	3	
203	36	691	495	B 5.4	B 6.4	20	15	15	10	1-1/2	3	
Unloading large tank cars, multiple vessels, barges or terminals	211	38	691	510	B 5.6	B 6.8	20	15	15	10	1-1/2	4
	218	39	691	530	B 5.8	B 7.0	20	15	15	15	1-1/2	4
	226	41	691	550	B 6.0	A 7.0	20	15	15	15	1-1/2	4
	233	42	691	565	B 6.2	B 7.4	20	15	15	15	2	4
	240	43	691	585	B 6.4	A 7.4	20	20	15	15	2	4
	248	45	691	605	B 6.6	B 8.0	20	20	15	15	2	4
	255	45	691	620	B 6.8		25	20	15	15	2	4
	263	47	691	640	B 7.0	A 8.2	25	20	15	15	2	4
	278	48	691	675	B 7.4	B 8.6	25	20	15	15	2	4
	301	54	691	730	B 8.0	B 9.4	25	20	20	15	2	4
	323	58	691	785	B 8.6		30	25	20	20	2	4
	338	60	691	820	TB 9.0	A 10.6	30	25	20	20	2	4
	459	82	D/FD891	580	5V 7.1	5V 8.5	40	30	30	30	3	6
633	113	D/FD891	800	5V 9.75	5V 11.8		40	40	30	3	6	

¹ The capacities shown are based on 70°F, but will vary depending upon piping, fittings used, product being transferred and temperature. The factory can supply a detailed computer analysis if required.

² Driver sheaves: 91 - 2 belts; 291, 491 - 3 belts; 691 - 4 belts.

³ The piping sizes shown are considered minimum. If the length exceeds 100 ft., use the next larger size.

Consult factory for compressors with higher flows.

Standard Compressor Mountings

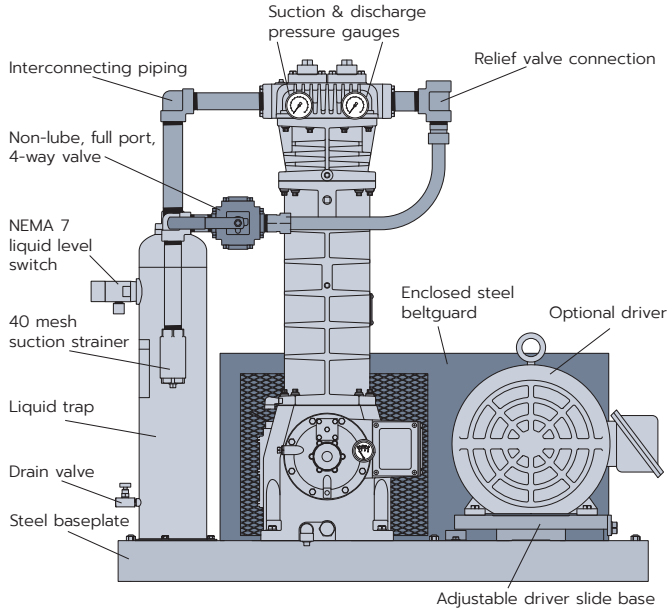

-107A mounting shown above.

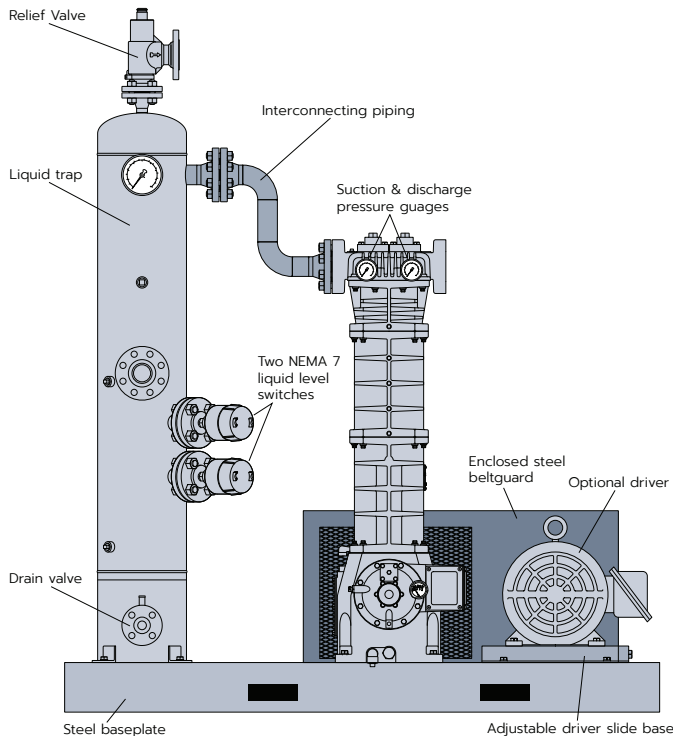

-109F mounting shown above.

Standard 107 Items

- Steel baseplate
- V-belt drive
- Adjustable driver side base
- Enclosed steel guard
- Suction and discharge pressure gauges
- 40 Micron strainer
- Non-lube 4-way valve
- Interconnecting piping
- Liquid trap as specified below

107 Mounting

- Mechanical liquid trap with ball float

107A Mounting

- Automatic liquid trap with one NEMA 7 liquid level switch

107B Mounting

- Automatic liquid trap with two NEMA 7 liquid level switches

107F Mounting

- 107A or 107B with Class 300 RF flanged components and connections

Standard 109 Items

- Steel baseplate
- V-belt drive
- Adjustable driver side base
- Enclosed steel guard
- Suction and discharge pressure gauges
- 40 Micron strainer
- Non-lube 4-way valve
- Interconnecting piping
- Liquid trap as specified below

109 Mounting

- Mechanical liquid trap with ball float

109A Mounting

- Automatic liquid trap with one NEMA 7 liquid level switch

109B Mounting

- Automatic liquid trap with two NEMA 7 liquid level switches

109F Mounting

- 109A or 109B with Class 300 RF flanged components and connections

Custom Engineered Compressor Packages

Custom engineered packages...

When a standard mounting does not fit into your application, Corken will customize one for you. Most custom packages are a modification of a standard mounting; however, if this does not meet your needs, Corken will start from scratch and build a mounting or skid from the floor up. Send in your specifications and one of Corken's application engineers will help design a package that meets your needs.

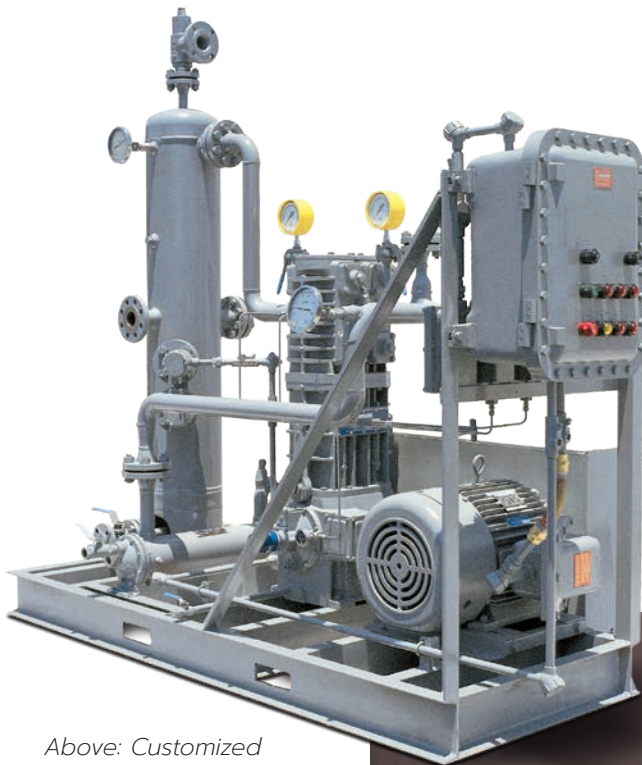

Above: Customized D891-109F single-stage compressor package designed for a liquefied gas transfer application.

Right: Customized HG602CE-109C two-stage compressor package designed for LPG sphere evacuation. This package can operate in single-stage and two-stage mode for deep evacuation. This package can also be used for propylene and other products.

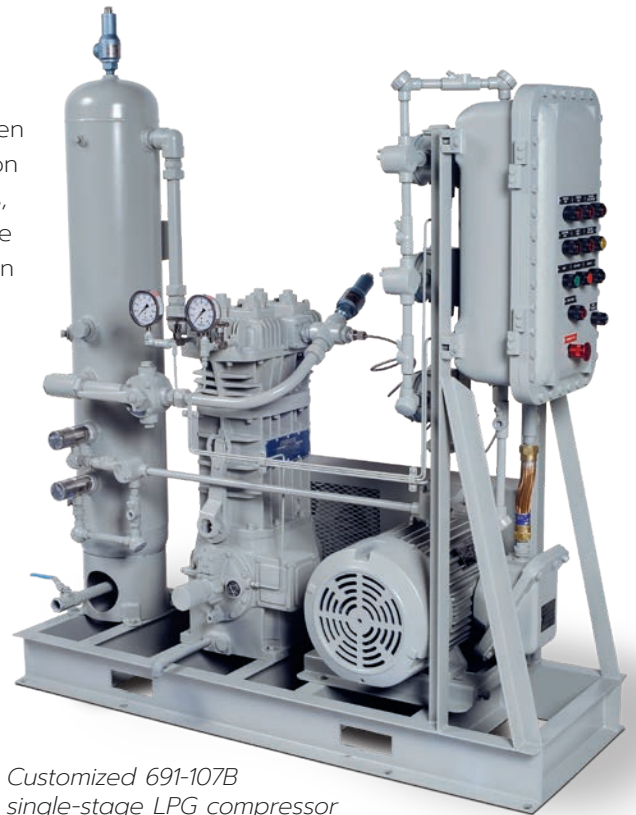

Customized 691-107B single-stage LPG compressor package designed for liquefied gas transfer and vapor recovery applications.



Bypass Valves

B166B (3/4", 1") Automatic Dual-Purpose Bypass Valve

Typical Application: Used with cylinder filling pumps and aerosol propellant feed pumps.

A combination bypass and priming valve specifically designed for small cylinder-filling type pumps, especially of the regenerative turbine type, such as the Corken Coro-Flo® pump series. The patented vapor elimination system keeps liquefied gas pumps primed to increase system reliability and decrease pump and seal wear. The B166B is a smooth operating bypass with moderate pressure build-up.



Specifications	Model		
	B166B	ZV200	B177
Inlet	3/4", 1"	2" (standard)	2", 2-1/2"
Outlet	3/4", 1"	2" (standard)	2", 2-1/2"
Slip-on flange option	No	Yes	Yes
Differential pressure range: psi (bar)	25–225 (1.7–15.5)	41–150 (2.8–10.3)	10–125 (0.7–8.6)
Max. working pressure	400 psig (27.6 bar g)		
O-ring material options	Buna-N (standard), Neoprene ^{®1} , PTFE, Viton ^{®1} , ethylene-propylene		

¹ Registered trademark of the DuPont Company.

B166B Performance

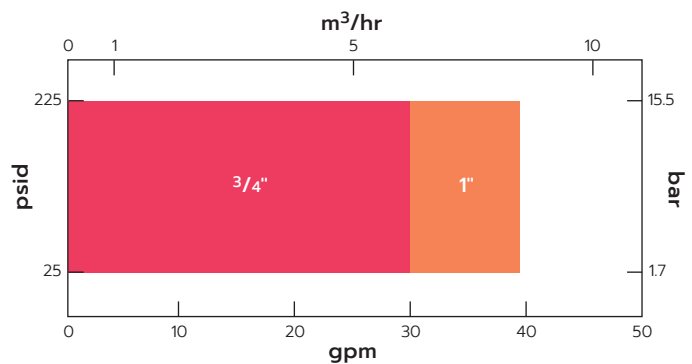

ZV200 (2") Bypass Valve

Typical Applications: Used with both truck and stationary pumps for loading and unloading.

A low-pressure build-up bypass valve designed for applications requiring protection for positive displacement pumps. The continuous internal bleed is ideal for systems with air or electric operated internal valves.



ZV200 Performance

Differential Pressure: psi (bar)	Maximum Rated Flow for Propane: gpm (L/min)
70 (4.82)	180 (681)
120 (8.27)	250 (946)

B177 (2", 2-1/2") Differential Bypass Valve

Typical Application: Used in bulk plant installations with large pumps that load and unload.

A low-pressure build-up bypass valve specifically designed for applications requiring protection for positive displacement pumps ranging from 50 to 350 gpm (11.4 to 79.5 m³/hr). It can also be used as a differential back-pressure valve to assure adequate pressure on meters. To properly function, this valve requires a pressure sensing line from the storage tank.



B177 Performance

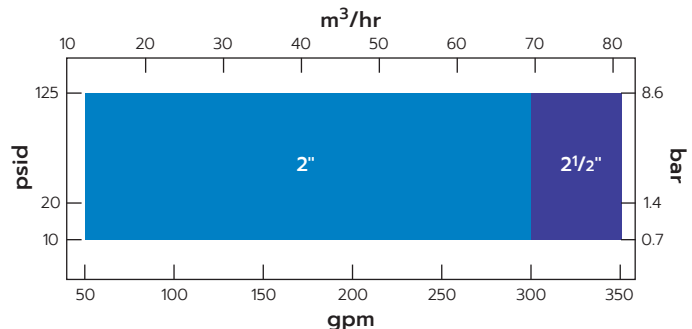

Accessories

4-Way Non-lubricated Valve

A convenient and simple means of reversing flow direction to a compressor. Made of ductile iron body, complete with handle and flow direction indicator (1" or 1-1/4" NPT and 2"–Class 300 RF flange, 500 psig rating [34.5 bar g]).



Low Oil Pressure Switch

A NEMA 7 pressure switch shuts down the compressor if the oil pressure drops below 10 psi (0.69 bar). Available in 120 or 230 volt and can be used with magnetic starters up to NEMA size 3.



Strainer

The right-angle design of the strainer minimizes pressure drop. It comes complete with a ductile iron body, monel screen, and steel plug. Available for liquid or vapor service (1-1/4" NPT 250 psig [17.2 bar] rating).



Pressure Gauge

Glycerine filled pressure gauge with stainless steel case mounts to the compressor head or in the piping system and comes with the following features:

- 0–400 psi (0–28 bar) range, 5 psi (0.34 bar) increment
- 2-1/2" dial with 1/4" NPT center back connection



Liquid Traps

Standard liquid trap with mechanical float assembly and drain valve.

Sizes:

- 1-1/4" x 1-1/4" NPT
- 1-1/4" x 1-1/2" NPT

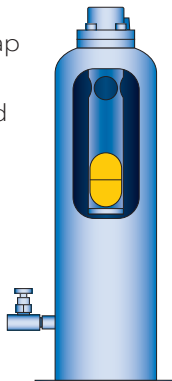

Automatic liquid trap, with one NEMA 7 liquid-level switch for compressor shutdown and alarm.

Sizes:

- 1-1/4" x 1-1/4" NPT
- 1-1/4" x 1-1/2" NPT

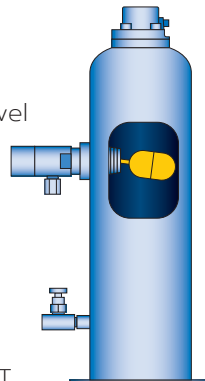

Class 300 RF flange code-stamped automatic liquid trap with two NEMA 7 liquid-level switches for compressor shutdown and alarm.

Equipped with relief valve, pressure gauge, demister pad, and drain valve.

Sizes:

- 1-1/2" x 1-1/2" NPT
- 2" x 2" Class 300 RF flange

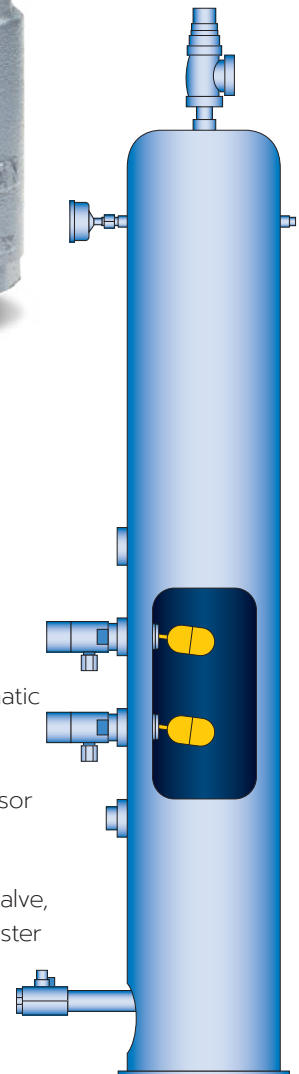

Solutions beyond products...

CORKEN[®]

CORKEN, INC. • A Unit of IDEX Corporation
3805 N.W. 36th St., Oklahoma City, OK 73112 U.S.A.
Phone (405) 946-5576 • FAX (405) 948-7343

Visit our website at <http://www.corken.com> • E-mail us at cocsalesdept@idexcorp.com



@CorkenInc

